



OPTOGAMA

KEY for DISCOVERIES

ULTRAFAST LASER SHUTTER v.1.2





Table of contents

1. Introduction.....	3
2. Specifications	4
3. Shutter alignment	6
4. Controller front panel description	7
5. Control via RS232.....	8
6. Control via USB port.....	11

1. Introduction

Laser Shutter is used for single or multiple exposure interruption. It can be used with high power lasers in custom spectral region from UV to IR. Operation of Laser Shutter is based on the fast galvanomagnetic scanner. Scanner is incorporated in nondispersive optical system assuring blanking speed better than parts of milliseconds. This design does not use any dispersive optical elements (lenses, prisms).

Laser shutters are applied in laser cutting, drilling, engraving, laser surgery systems, research, etc.

Shutter system includes galvo scanner, driver, mount, controller, control cable. As an option a green or red diode laser should be applied for system alignment (not included).

The optical beam path inside in the beam shutter is presented in Fig.1.

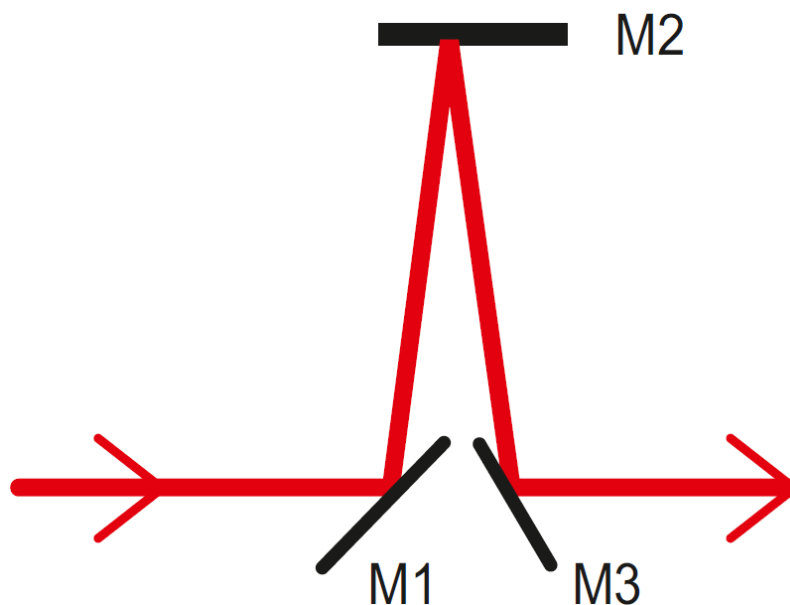

Fig. 1 Beam diagram of collinear nondispersive fast laser shutter. M1-rotating galvo mirror, M2 and M3-adjustable mirrors.

2. Specifications

Incident beam diameter	<10 mm*
Laser beam polarization	Independent
Max Laser power	200 W
Switching frequency range	0-500 Hz
Closed-opened switching time	<0.2 ms
Typical switching time (opened-opened)	<0,5 ms
Control via RS232 port	Available
Control via USB port	Available
Control from external (0-5V) generator	Available
Control from internal (0-5V) generator	Available
Manual control	Available
Manual switching	Available
Shutter position indication	Available
Shutter dimensions	200 x 40 x 60 mm
Electronic box, max	145 x 215 x 86 mm
Electrical power consumption, not more	100/220 V, 30 W

*optional up to 30mm

Open- close switching time and residual scattered light are the main parameters of shutter device. Typical exposure pulse form is given in Fig.3.

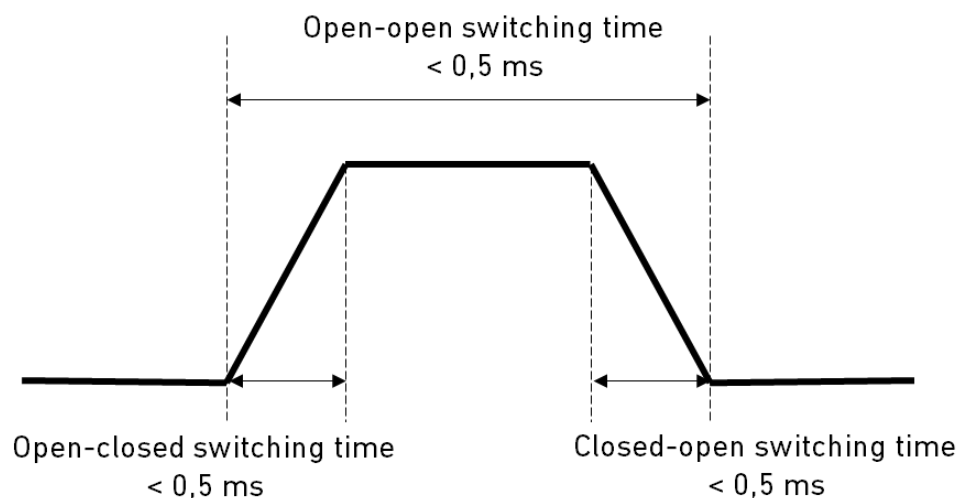

Fig. 2 Typical exposure pulse form

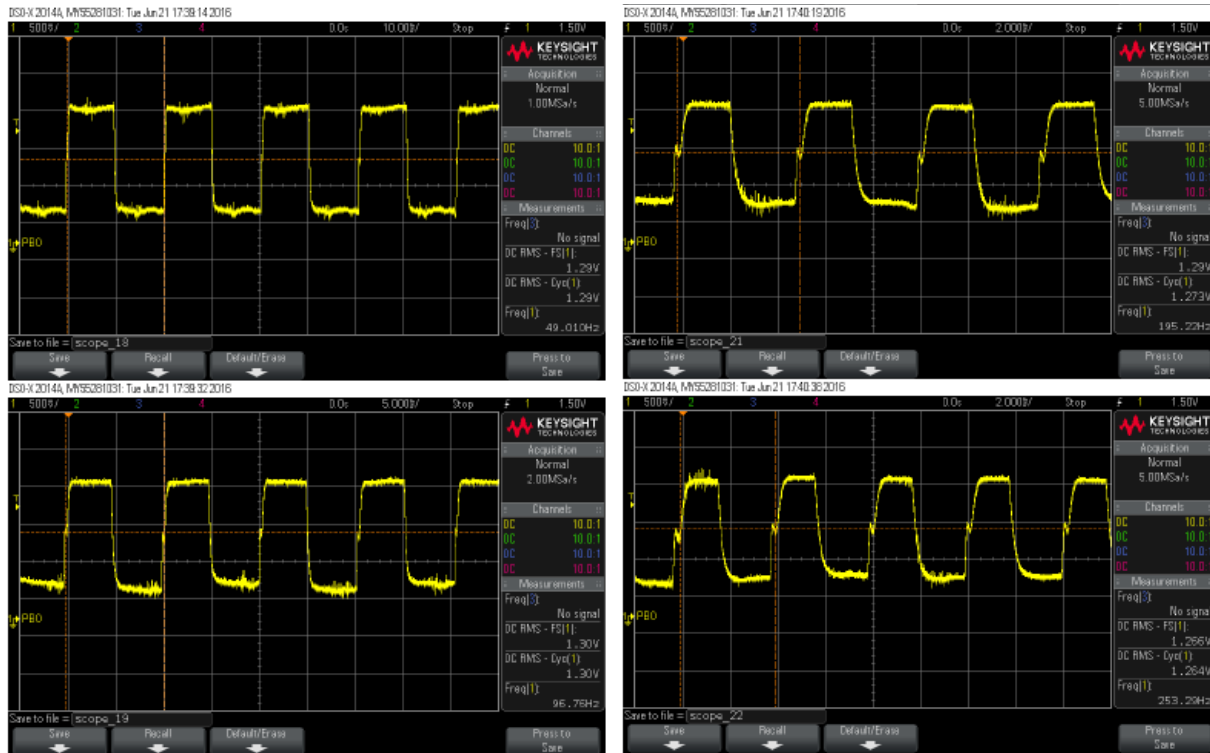

Fig. 3 Typical laser oscillograms at 50 Hz, 100 Hz, 200 Hz and 250 Hz rates using shutter.

3. Shutter alignment

Shutter is factory aligned and prepared for work.

Alignment of system is very simple and takes only few minutes. We do recommend using additional red or green laser in order to align the system precisely. Please keep following order:

1. Align the additional visible laser beam with Your main laser beam.
2. Align beam into the center of shutter's input hole perpendicularly to the front surface of shutter. For that we recommend pressing a metal mirror to front surface and getting a backward reflection.
3. Make sure the buttons are set "OPEN", "MAN", "ANALOG". Rotate potentiometer "ANGLE" fully counterclockwise.
4. Switch on the controller power supply. The galvo scanner mirror then takes position parallel to optical axis (Fig.1). It corresponds to low TTL level and position "beam opened". Under good alignment of system, you will see a 100% visible beam throw over the output hole of shutter.
5. Set the switcher to position "CLOSE". Under the rotation of potentiometer "Angle" clockwise You should get a complete closing of beam. Now shutter is prepared to work.

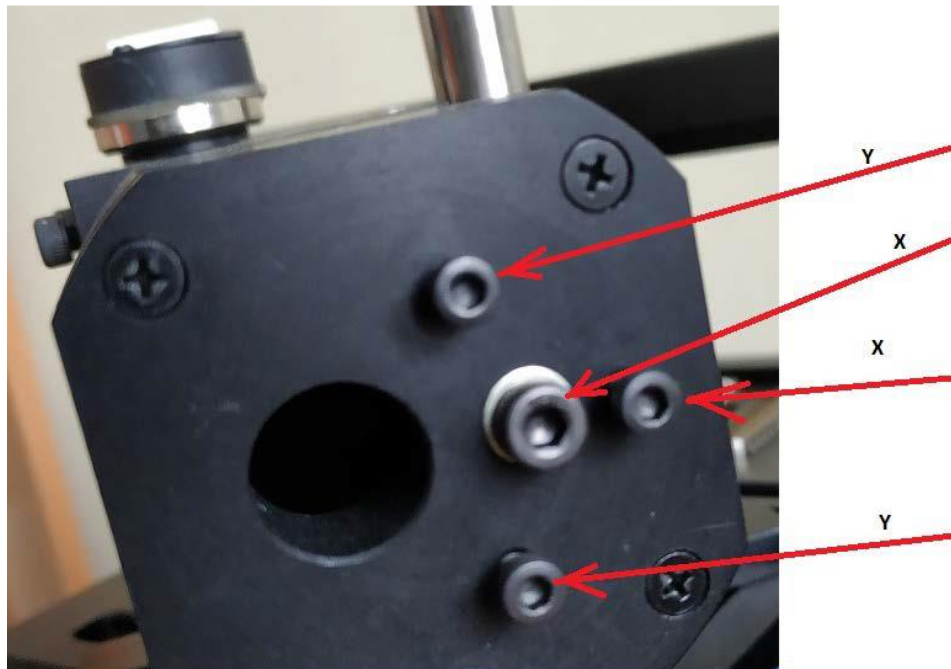

Fig. 4 Description of X-Y alignment screws.

4. Controller front panel description



Fig. 5 Front panel of shutter controller

“OPEN/CLOSE” –Shutter manual switch.

Rotating potentiometer on front panel one changes angle of galvo mirror. Complete damping of laser beam is reached when the switch is in “Close” position. This angle remains valid even when the shutter is controlled via external generator.

“MAN/EXT” – the switch position indicates whether the shutter is controlled manually (with potentiometer on front panel) or by using external pulse generator.

“Analog/Computer” – The switch position indicates whether the shutter is driven by analog or computer signal.

With “Analog” position switched the shutter is controlled manually via internal DC power supply or externally using pulse generator. TTL Low signal (Ground) corresponds “Open” position (100% transmission), whereas TTL High (+5V) corresponds “Close” position.

With “Computer” position switched, the TTL pulses are generated from internal generator. One can change the frequency by commands (see below Control via RS232 port).

“GEN” – is used for external triggering using positive TTL pulses +(2-5) V. In this case switcher “Manual/External” should be in position “External”, switcher “Analog/Computer” in position “Analog”. The amplitude of scanner angle between Close/Open positions is controlled via potentiometer on front panel. Please note that shutter has delay relative to triggering pulse due to inertia of mirror.

“SINC” – output signal for shutter operation in “master” mode. You can delay laser output relative to shutter up to 300mks.

“Galvo” – Galvano scanner connection.

“RS232” – RS232 control connection

“USB” – Connection for USB2 or USB3 port. When the USB port is connected, the RS232 connection is automatically disconnected in order to avoid the duplication. RS232 connection is reconnected after USB cable is pulled out.

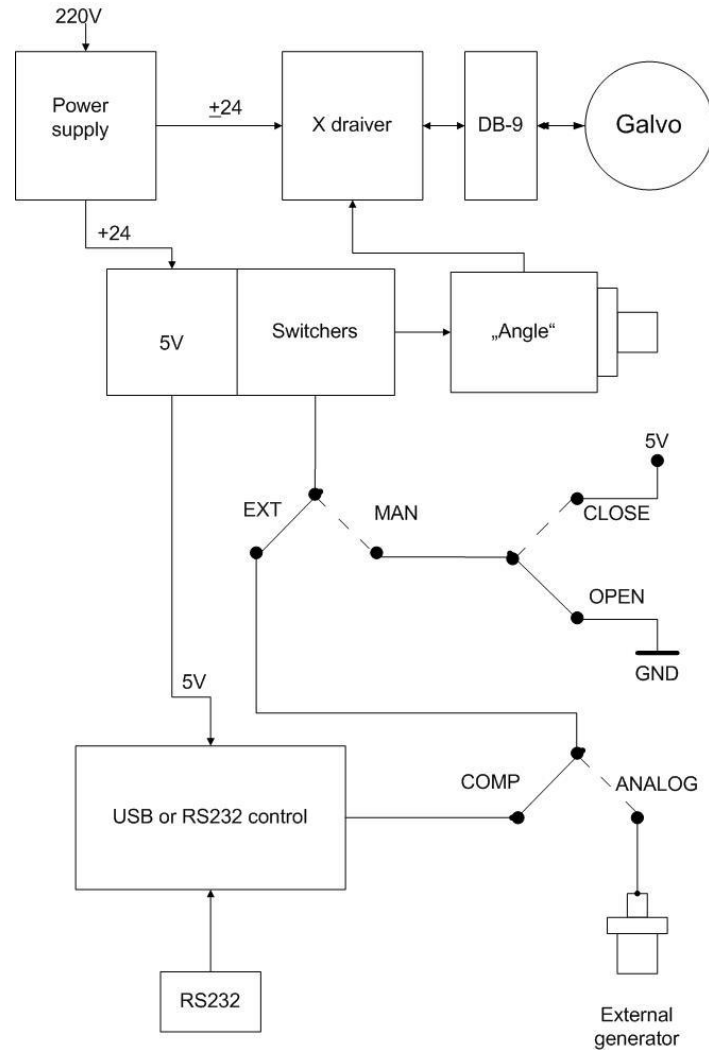
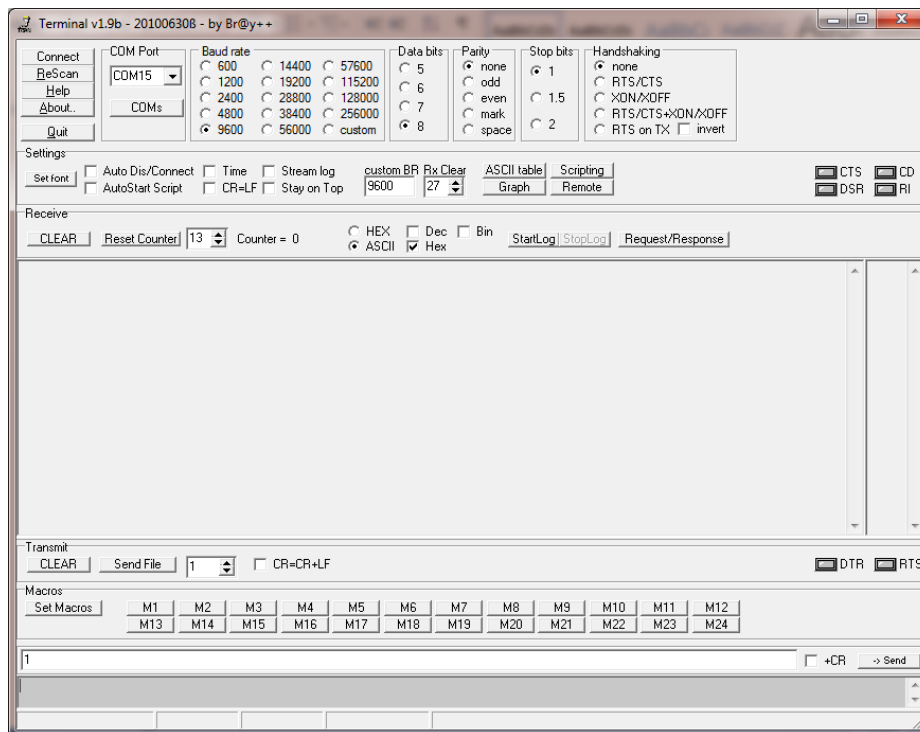
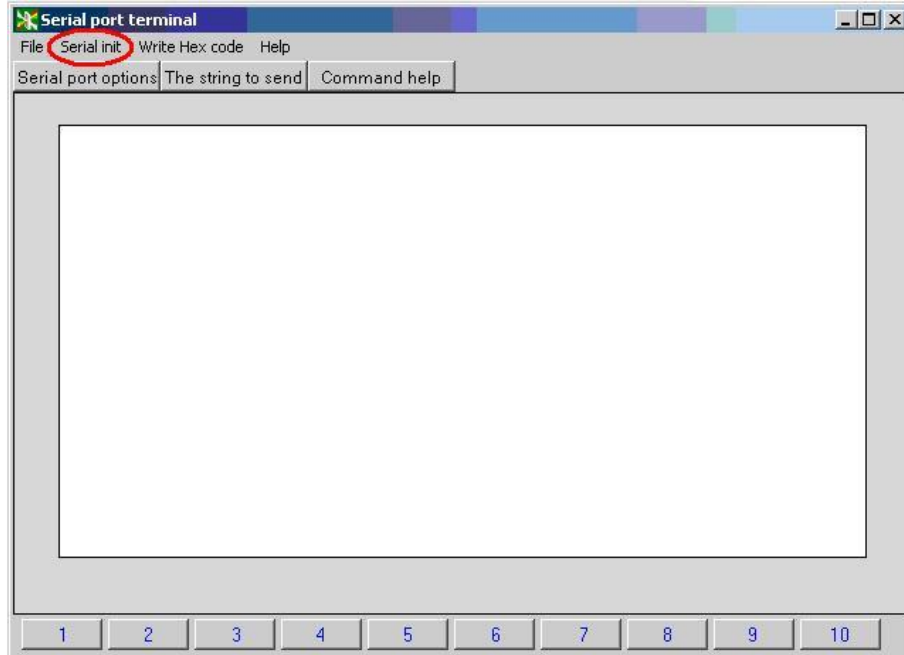

Fig. 6 Schematics of switchers

5. Control via RS232

Program is started through “serial port terminal.exe” file. When the program window opens, please select and activate COM port. This should be done in “serial int” menu, shown in Fig.7. Please enter the used COM port. After that you are free to enter commands which are listed below.



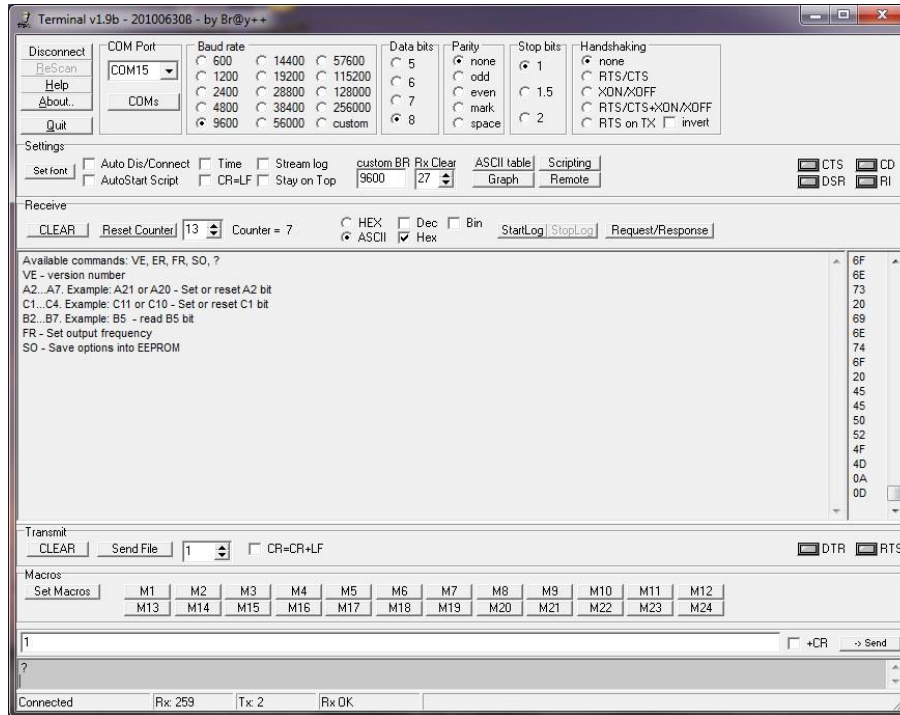

Fig. 7 Interface of program

Installation: Put both files "Serial port terminal.exe" and "Bwcc32.dll" into the same directory. Some default commands can be read by "Serial port terminal.exe" from "by default.cfg" file. Note: "Bwcc32.dll" is standard Borland C++ 5.02 dynamic library file, found in the C++ 5.02.

UART configuration:

Bound rate: 9600
 Data bits: 8
 Parity: None
 Step bits: 1
 Handshaking: none

Commands:

? – help menu
 a70 – open shutter
 a71 – close shutter
 frX – frequency of opening/closing, where X means frequency (min value 0, max 1000)
 NOTE: RS-232 has its own standard where digital 1 =+3...9V and 0=-3...-9V. PC and TTL interface have microchips – level converters, which change these analog signals to TTL standard signals. Through RS232 cable commands are sent in ASCII codes.



6. Control via USB port

Controlling the Shutter via USB, one must download the additional driver.

Driver for USB virtual COM port You can find here:

<https://www.silabs.com/products/development-tools/software/usb-to-uart-bridge-vcp-drivers>

When the USB port is connected, the RS232 connection is automatically disconnected in order to avoid the signal duplication. RS232 connection is reconnected after USB cable is pulled out.

OPTOGAMA, UAB
Mokslininku str. 2A,
LT-08412, Vilnius, Lithuania
+37052194884
sales@optogama.com
www.optogama.com



OPTOGAMA